

第二章 無障礙通路圖例 適用者 " " "

出入口(操作空間)

出入口(門把)

出入口(門把)

坡道(坡道邊緣防護)

扶手(與避面距離)

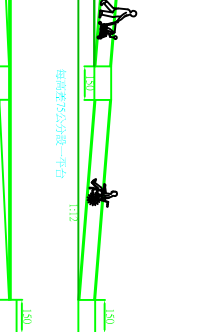
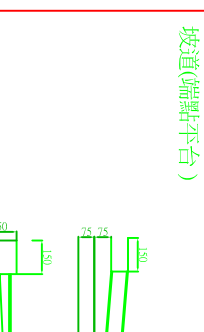
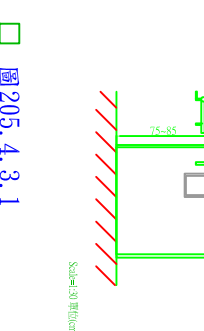
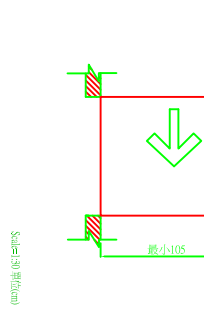
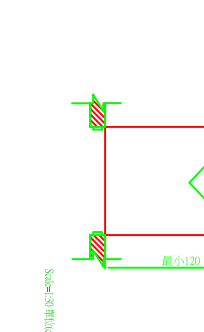
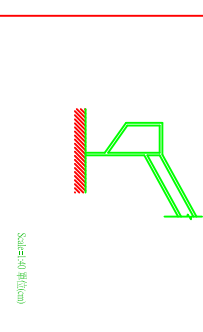
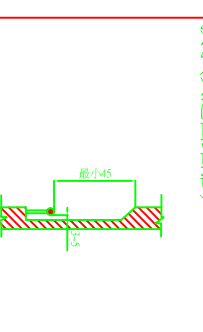
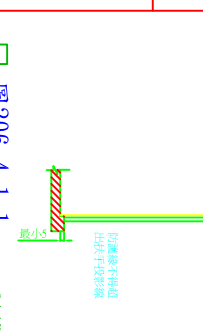
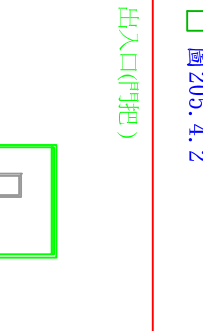
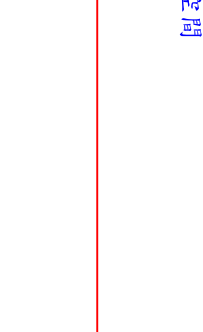
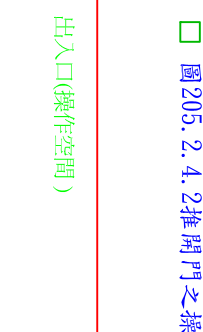
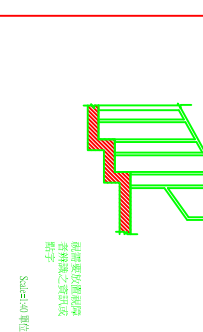
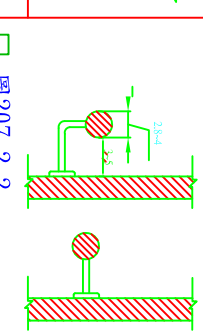
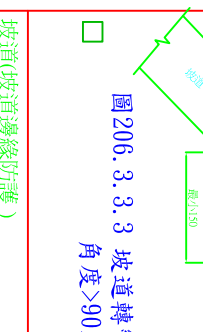
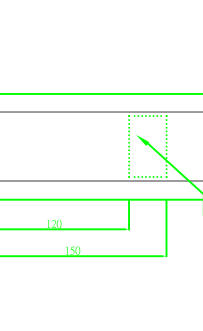
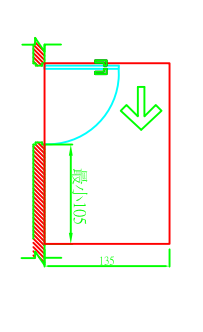
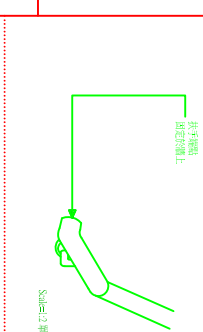
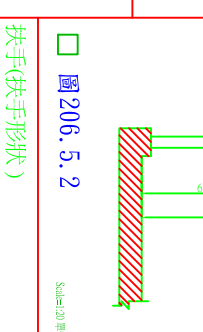
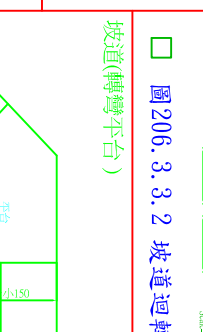
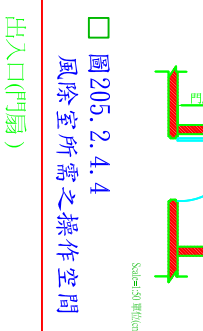
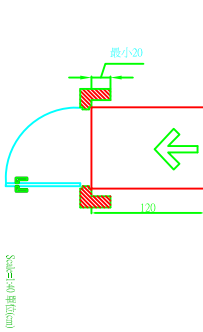
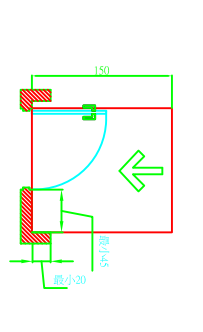
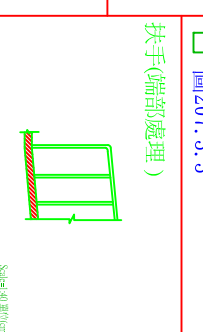
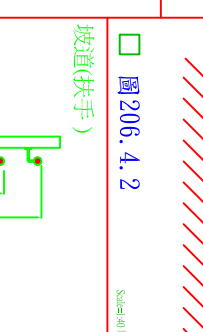
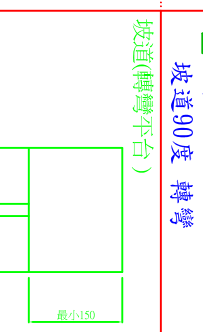
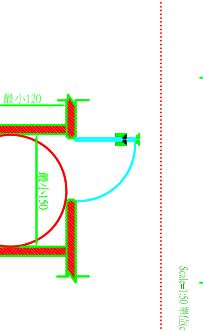
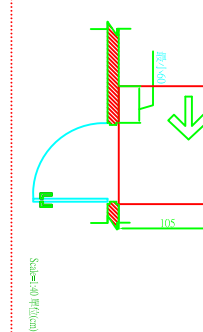
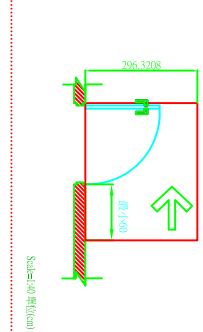
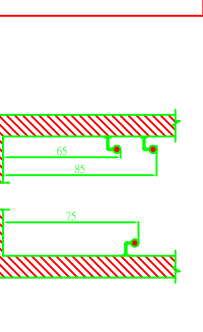
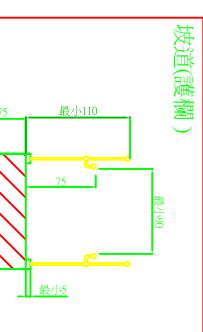
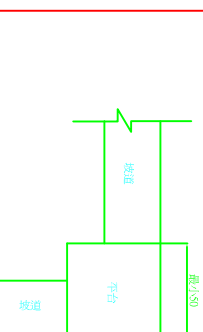
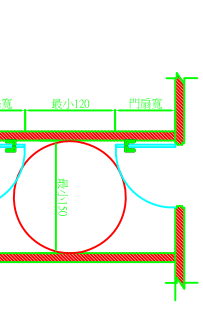
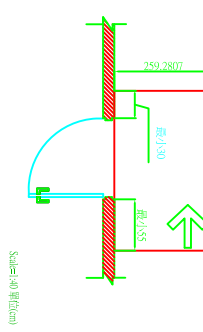
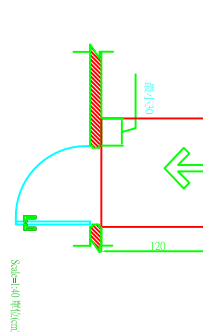
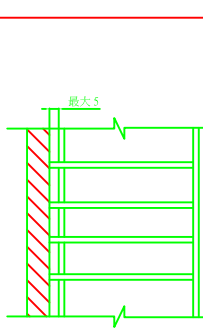
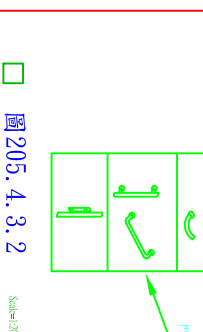
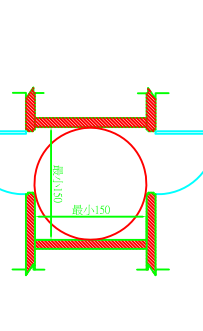
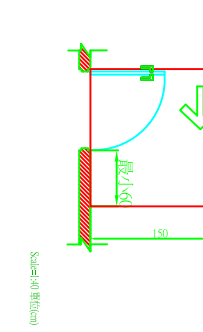
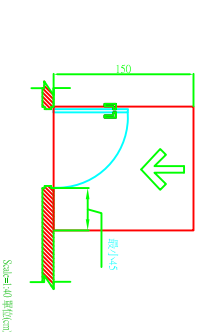

工程名稱

修正

核准

日期

圖名

張號

第

圖號

第

社團法人新北市建築師公會

業務號碼

設計

繪圖

校核

業務號碼

第三章 樓梯 適用者 " " "

通則

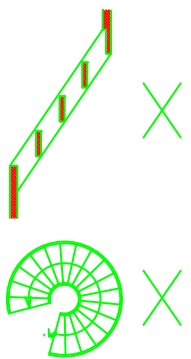

□ 圖301.1

Scale: 1/50 (Elevation)

樓梯設計(樓梯底板高度)

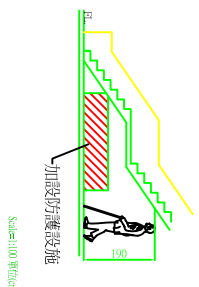

Scale: 1/100 (Elevation)

□ 圖302.1

樓梯設計(樓梯轉打設計)

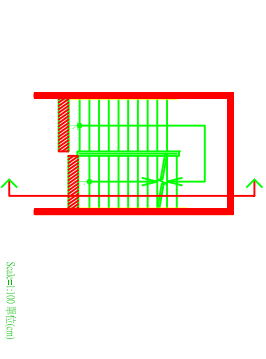

Scale: 1/100 (Elevation)

□ 圖302.2

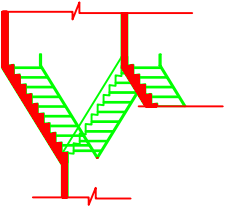

Scale: 1/100 (Elevation)

梯級(級高及級深)

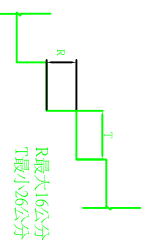

□ 圖303.1

Scale: 1/20 (Elevation)

梯級(梯級鼻端)

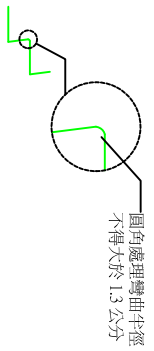

□ 圖303.2.1

Scale: 1/30 (Elevation)

梯級(梯級鼻端)

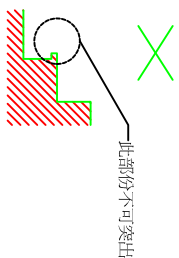

Scale: 1/20 (Elevation)

此部份不可突出

□ 圖303.2.2

Scale: 1/30 (Elevation)

梯級(防滑條)

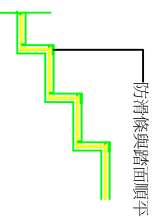

Scale: 1/30 (Elevation)

□ 圖303.3

梯級(防護線)



Scale: 1/30 (Elevation)

□ 圖303.4

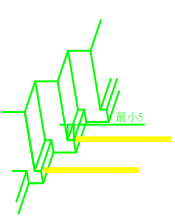

Scale: 1/30 (Elevation)

梯級(級高及級深)

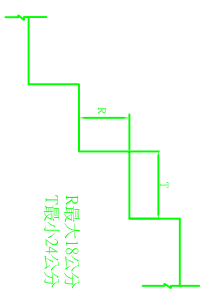

□ 圖303.5.2

Scale: 1/30 (Elevation)

扶手與欄杆(扶手)

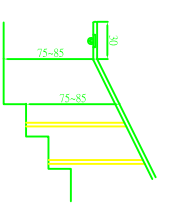

□ 圖304.1

Scale: 1/30 (Elevation)

扶手與欄杆(水平延伸)

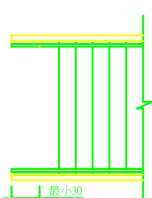

Scale: 1/30 (Elevation)

□ 圖304.2.1

扶手與欄杆(水平延伸)

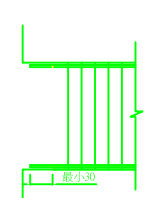

Scale: 1/30 (Elevation)

□ 圖304.2.2

警示設施(終端警示)

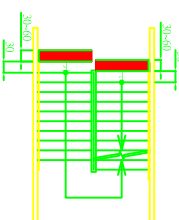

Scale: 1/100 (Elevation)

□ 圖305.1

第四章 昇降設備 適用者 " " "

引導標誌(入口引導)

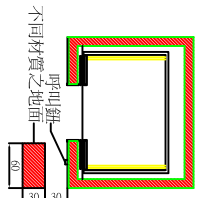

Scale: 1/30 (Elevation)

□ 圖403.2

引導標誌(突出牆壁)

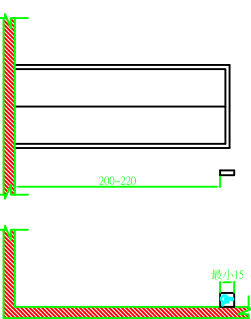

Scale: 1/30 (Elevation)

□ 圖403.3.1

引導標誌(平行牆面)

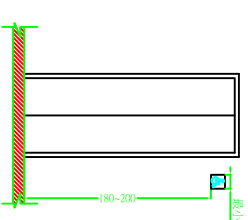

Scale: 1/30 (Elevation)

□ 圖403.3.2

昇降機出入平台(停靠處)  
(昇降機呼叫鈕)

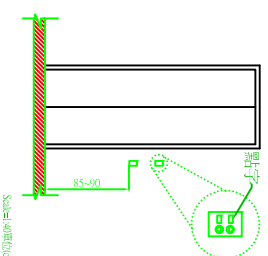

Scale: 1/30 (Elevation)

□ 圖404.2

昇降機出入平台(停靠處)  
(昇降機出入口的感觸裝置)

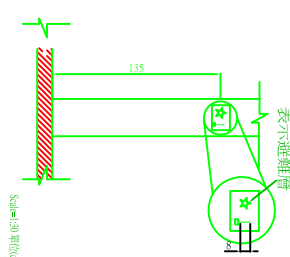

Scale: 1/30 (Elevation)

□ 圖404.3

昇降機廂(機廂尺寸)

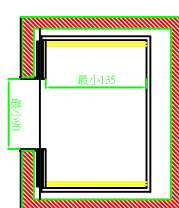

Scale: 1/30 (Elevation)

□ 圖406.1

昇降機廂(輪椅乘坐者操作盤)

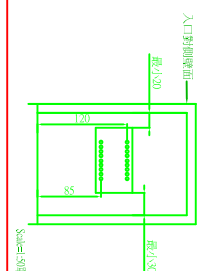

Scale: 1/30 (Elevation)

□ 圖406.4

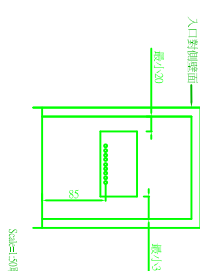

Scale: 1/30 (Elevation)

昇降機廂(按鈕)

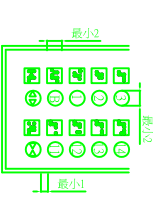

Scale: 1/30 (Elevation)

□ 圖406.5

工程名稱

修正

社團法人新北市建築師公會

核准

日期

圖名

張號

第

章

校核

日期

圖名

張號

第

章

繪圖



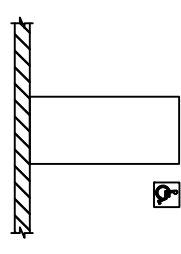
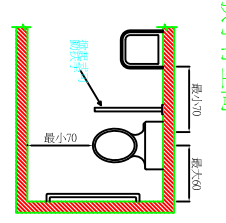
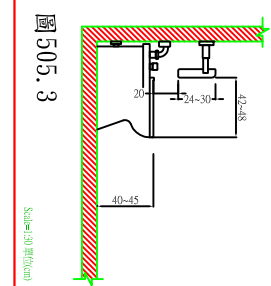
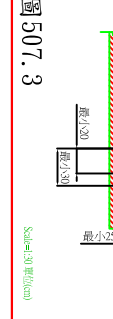
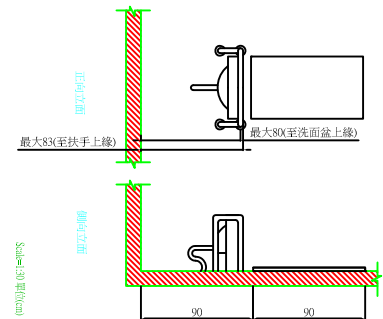
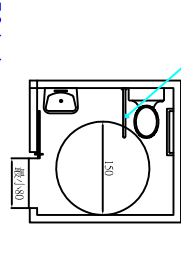
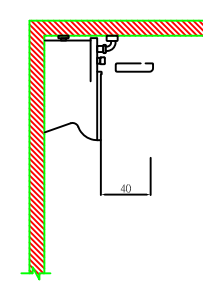
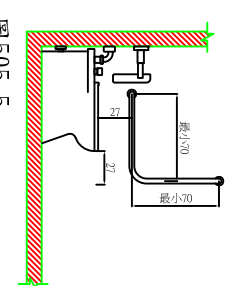
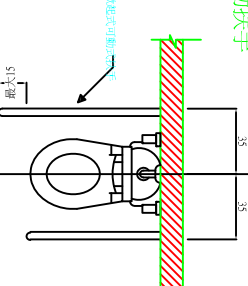
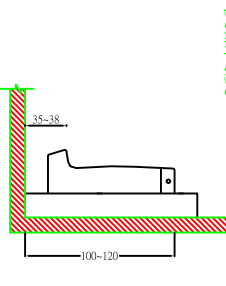
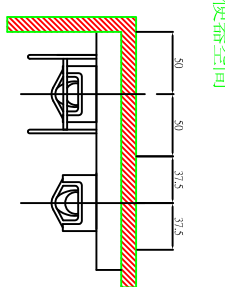
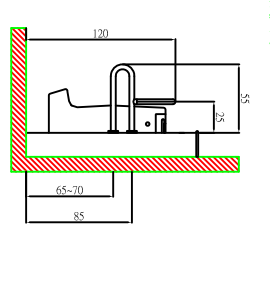
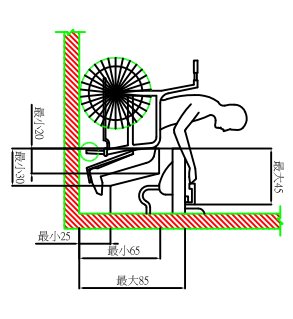
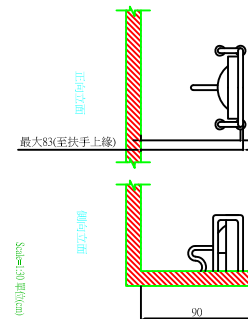
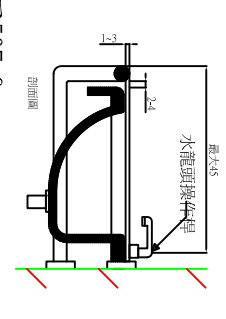

設計

業務號碼

第五章 廁所盥洗室 適用者 " " "

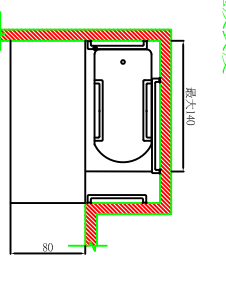
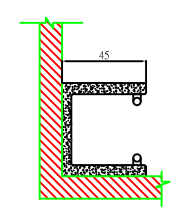
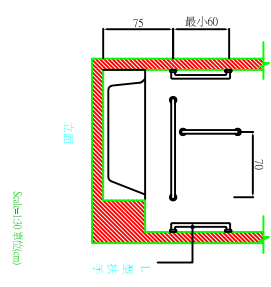
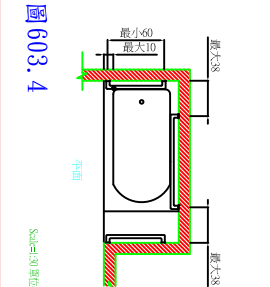
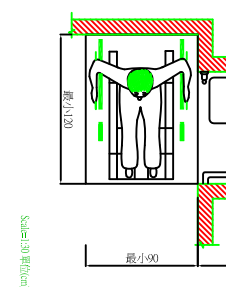
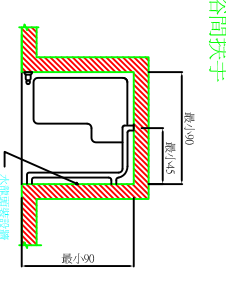
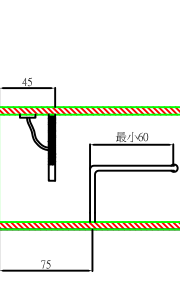
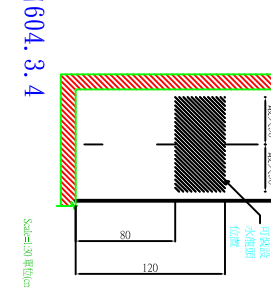
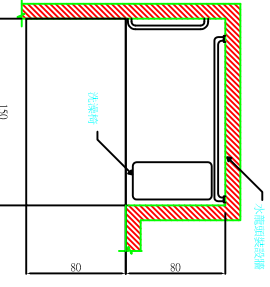
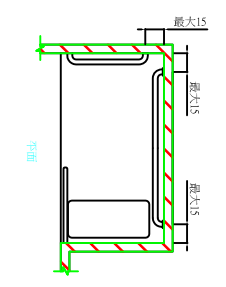
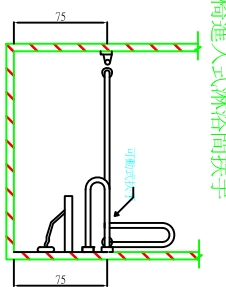
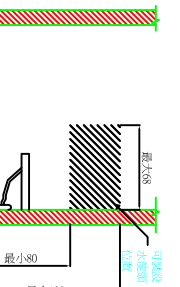
<p>引導標誌</p>  <p>圖 503.2.1 Scale: 1/30 單位:mm</p>	<p>馬桶及扶手淨空間</p>  <p>圖 505.2 Scale: 1/30 單位:mm</p>	<p>小便器扶手</p>  <p>圖 506.5 Scale: 1/30 單位:mm</p>	<p>小便器高度</p>  <p>圖 507.3 Scale: 1/30 單位:mm</p>	<p>洗面盆高度</p>  <p>圖 507.6 Scale: 1/30 單位:mm</p>	<p>圖 504.1 Scale: 1/30 單位:mm</p>
<p>馬桶淨空間</p>  <p>圖 504.1 Scale: 1/30 單位:mm</p>	<p>沖水控制</p>  <p>圖 505.4 Scale: 1/30 單位:mm</p>	<p>側邊L型扶手</p>  <p>圖 505.5 Scale: 1/30 單位:mm</p>	<p>可動扶手</p>  <p>圖 505.6 Scale: 1/30 單位:mm</p>	<p>小便器高度</p>  <p>圖 506.3 Scale: 1/30 單位:mm</p>	<p>圖 504.2 Scale: 1/30 單位:mm</p>
<p>小便器淨空間</p>  <p>圖 506.5 Scale: 1/30 單位:mm</p>	<p>小便器扶手</p>  <p>圖 506.6 Scale: 1/30 單位:mm</p>	<p>洗面盆高度</p>  <p>圖 507.3 Scale: 1/30 單位:mm</p>	<p>可動扶手</p>  <p>圖 505.6 Scale: 1/30 單位:mm</p>	<p>洗面盆高度</p>  <p>圖 507.6 Scale: 1/30 單位:mm</p>	<p>圖 504.2 Scale: 1/30 單位:mm</p>

第六章 浴室 適用者 " " "

<p>浴缸位置及長度</p>  <p>圖 603.2 Scale: 1/30 單位:mm</p>	<p>浴缸高度</p>  <p>圖 603.3 Scale: 1/20 單位:mm</p>	<p>浴缸扶手</p>  <p>圖 603.4 Scale: 1/30 單位:mm</p>	<p>淋浴間尺寸</p>  <p>圖 603.4 Scale: 1/30 單位:mm</p>	<p>淋浴間尺寸</p>  <p>圖 604.3.2 Scale: 1/30 單位:mm</p>	<p>圖 604.3.2 Scale: 1/30 單位:mm</p>
<p>淋浴間扶手</p>  <p>圖 604.3.2 Scale: 1/30 單位:mm</p>	<p>淋浴間扶手</p>  <p>圖 604.3.3 Scale: 1/30 單位:mm</p>	<p>淋浴間水龍頭位置</p>  <p>圖 604.3.4 Scale: 1/30 單位:mm</p>	<p>輪椅進入式淋浴間尺寸</p>  <p>圖 604.4.2 Scale: 1/30 單位:mm</p>	<p>輪椅進入式淋浴間扶手</p>  <p>圖 604.4.3 Scale: 1/30 單位:mm</p>	<p>圖 604.3.2 Scale: 1/30 單位:mm</p>
<p>輪椅進入式淋浴間扶手</p>  <p>圖 604.4.3 Scale: 1/30 單位:mm</p>	<p>輪椅進入式淋浴間水龍頭位置</p>  <p>圖 604.4.4 Scale: 1/30 單位:mm</p>	<p>輪椅進入式淋浴間水龍頭位置</p>  <p>圖 604.4.4 Scale: 1/30 單位:mm</p>	<p>輪椅進入式淋浴間尺寸</p>  <p>圖 604.4.2 Scale: 1/30 單位:mm</p>	<p>輪椅進入式淋浴間扶手</p>  <p>圖 604.4.3 Scale: 1/30 單位:mm</p>	<p>圖 604.4.3 Scale: 1/30 單位:mm</p>

工程名稱

修正

社團法人新北市建築師公會

核准	日期	圖名
校核		
繪圖		
設計		
業務號碼		

張數	圖號	簽章

第七章 輪椅觀眾席位 適用者 " " "

(固定銀幕水平能見度容許範圍)



圖 702.4.1  
Scale: 200 倍(5mm)

輪椅觀眾席位  
(固定銀幕仰視能見度容許範圍)

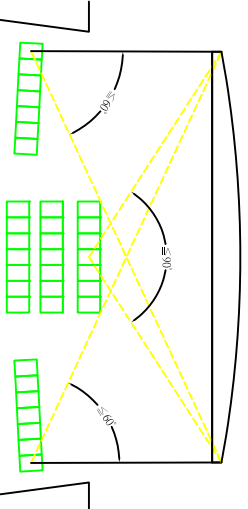

圖 702.4.2  
Scale: 1:50 倍(5mm)

輪椅觀眾席位  
(空間尺寸:寬度)

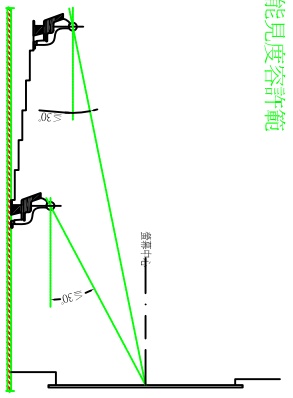

圖 703.1  
Scale: 1:50 倍(5mm)

輪椅觀眾席位  
(空間尺寸:深度)



圖 703.2.1  
Scale: 1:50 倍(5mm)

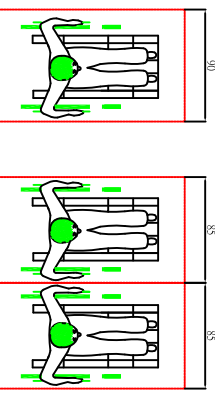

圖 703.2.2  
Scale: 1:50 倍(5mm)

輪椅觀眾席位  
(配置:位置)

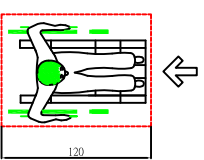

圖 704.2  
Scale: 1:50 倍(5mm)

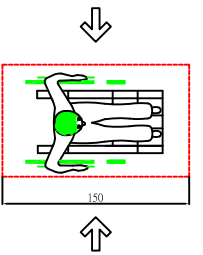
第八章 停車空間 適用者 " " "

輪椅觀眾席位  
(配置:欄杆)

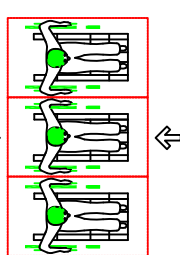

圖 704.5  
Scale: 1:50 倍(5mm)

停車空間引導標誌  
(單位豎立標誌)

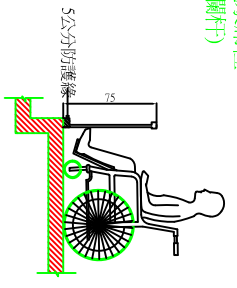

圖 803.2.1  
Scale: 1:100 倍(5mm)

停車空間引導標誌  
(單位地面標誌)

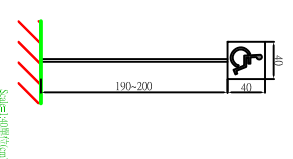

圖 803.3  
Scale: 1:100 倍(5mm)

停車空間  
(機車停車位)

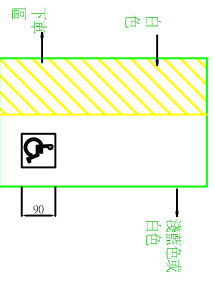

圖 805.1  
Scale: 1:100 倍(5mm)

第九章 無障礙標誌

無障礙標誌

圖例說明:圖中台「下」圖例中之比例  
為字體高度與字體寬度之比例。正立圖之圖例為

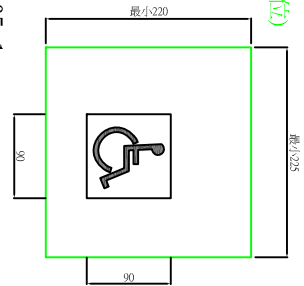

圖 902.1

停車空間汽車停車位  
(單一停車位)



圖 804.1  
Scale: 1:100 倍(5mm)

停車空間汽車停車位  
(相鄰停車位)

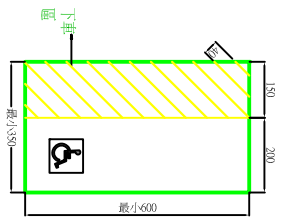

圖 804.2  
Scale: 1:100 倍(5mm)

工程名稱

修正

社團法人新北市建築師公會

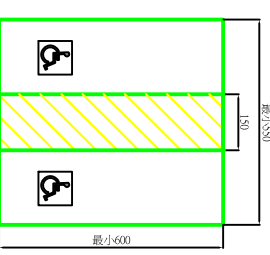
核准

日期

圖名

張號

第

校核

繪圖

設計

圖號

第

業務號碼